

APPENDIX D

AIRPORT BUSINESS PARK SIGN DETAIL AND SPECIFICATIONS

CITY OF ARLINGTON

100% Submittal
02.25.09

**Arlington Municipal Airport
Exterior Signage Master Plan**

Illum Associates, Inc.
ILLUM

RELEVANT CITY SIGN CODE:

- ZONING AF - Non-residential sub-division = maximum sign surface: 60 sq. ft., maximum sign height: 6 ft., allowed 1 sign per entry.
- ZONING LL - Non-residential sub-division = maximum sign surface: 60 sq. ft., maximum sign height: 6 ft., allowed 1 sign per entry.
- ZONING BP - Non-residential sub-division = maximum sign surface: 60 sq. ft., maximum sign height: 6 ft., allowed 1 sign per entry.
- Support structure is exempt from computation of sign area.

NOTES:

1. Refer to graphic components sheets AS-305, AS-306 & AS-307 for color schedule. All signs, including graphics & color to comply with the graphic components section of this book.
2. Sign type is single or double-sided.
3. No visible fasteners.
4. Sign type is non-illuminated.

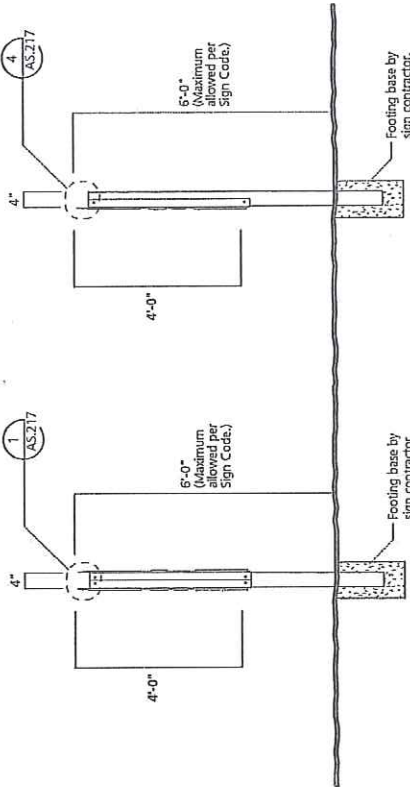
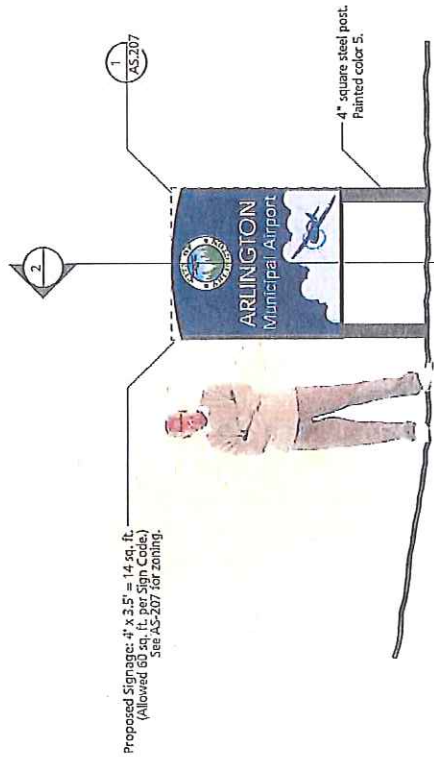
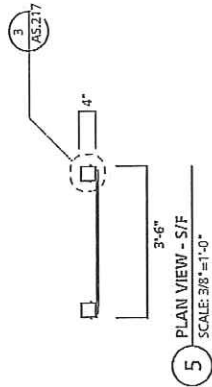
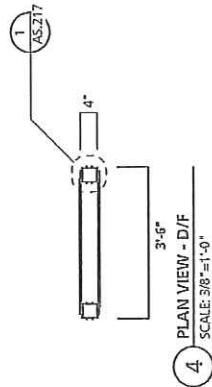

CONTRACT NO.
000

CLIENT:
City of Arlington

PROJECT:
Arlington Municipal Airport:
Exterior Signage Master Plan

JOB NUMBER:
1815.000

100% SUBMITTAL:
03/23/09

SIGN TYPE A3:

TERTIARY
DISTRICT
MARKER

SIGN TYPES:
IDENTIFICATION

AS-206

ILLUM ASSOCIATES, INC.
600 108th Avenue NE, Suite 660
Bellevue, WA 98004
T: 425.646.6525



CONTRACT NO.
000

CLIENT:
City of Arlington

PROJECT:
Arlington Municipal Airport
Exterior Signage Master Plan

JOB NUMBER:
1819.000

100% SUBMITTAL:
02/25/09

SIGN TYPE A3:
SIGN FACE DETAILS

SIGN TYPES:
IDENTIFICATION

AS-207

NOTES:
 1. Refer to graphic components sheets AS-305, AS-306 & AS-307 for color schedule. All signs, including graphics & color to comply with the graphic components section of this book.

10" diameter screen-printed logo. Color 4, 5, 6, 7. Mounted flush to sign panel.

3 1/2" U/C text. Painted color 4. Mounted flush to sign panel.

1/8" thick steel divider. Painted color 4. Mounted flush to sign panel.

3" U/C text. Painted color 4. Mounted flush to sign panel.

1/4" thick steel letters. Painted color 4. Mounted flush to sign panel.

Loc. Plan: AS-101
Sign No.: A3.10.01 (S/F)
Color scheme A

Allowed Signage: ±1250 feet of frontage x 0.3 = 375 sq. ft. (60 sq. ft. maximum per Sign Code.)
 Proposed Signage: 4' x 3.5' = 14 sq. ft.

10" diameter screen-printed logo. Color 4, 5, 6, 7. Mounted flush to sign panel.

3 1/2" U/C text. Painted color 4. Mounted flush to sign panel.

1/8" thick steel divider. Painted color 4. Mounted flush to sign panel.

3" U/C text. Painted color 4. Mounted flush to sign panel.

1/4" thick steel letters. Painted color 4. Mounted flush to sign panel.

Loc. Plan: AS-102
Sign No.: A3.14.02 (S/F)
Color scheme E

Allowed Signage: ±2250 feet of frontage x 0.3 = 675 sq. ft. (60 sq. ft. maximum per Sign Code.)
 Proposed Signage: 4' x 3.5' = 14 sq. ft.

10" diameter screen-printed logo. Color 4, 5, 6, 7. Mounted flush to sign panel.

3 1/2" U/C text. Painted color 4. Mounted flush to sign panel.

1/8" thick steel divider. Painted color 4. Mounted flush to sign panel.

3" U/C text. Painted color 4. Mounted flush to sign panel.

1/4" thick steel letters. Painted color 4. Mounted flush to sign panel.

Loc. Plan: AS-105
Sign No.: A3.15.03 (S/F)
Color scheme F

Allowed Signage: ±2500 feet of frontage x 0.3 = 750 sq. ft. (60 sq. ft. maximum per Sign Code.)
 Proposed Signage: 4' x 3.5' = 14 sq. ft.

10" diameter screen-printed logo. Color 4, 5, 6, 7. Mounted flush to sign panel.

3 1/2" U/C text. Painted color 4. Mounted flush to sign panel.

1/8" thick steel divider. Painted color 4. Mounted flush to sign panel.

3" U/C text. Painted color 4. Mounted flush to sign panel.

1/4" thick steel letters. Painted color 4. Mounted flush to sign panel.

Loc. Plan: AS-106
Sign No.: A3.16.05 (D/F), A3.16.07 (S/F), A3.16.08 (D/F), A3.16.09 (S/F)
Color scheme G

Allowed Signage: ±2250 feet of frontage x 0.3 = 675 sq. ft. (60 sq. ft. maximum per Sign Code.)
 Proposed Signage: 4' x 3.5' = 14 sq. ft.

15" diameter screen-printed logo. Color 4, 5, 6, 7. Mounted flush to sign panel.

4 1/2" U/C text. Painted color 4. Mounted flush to sign panel.

3 1/2" U/C text. Painted color 4. Mounted flush to sign panel.

1/4" thick steel letters. Painted color 4. Mounted flush to sign panel.

1/8" thick steel divider. Painted color 4. Mounted flush to sign panel.

3" U/C text. Painted color 4. Mounted flush to sign panel.

1/4" thick steel letters. Painted color 4. Mounted flush to sign panel.

1-3" x 2-6" mechanically fastened to post. Painted color 5.

1/4" thick steel graphic. Mounted flush to sign panel.

1/8" thick steel back panel. Mechanically fastened to post. Painted color 5.

4 1/2" U/C text. Painted color 4. Mounted flush to sign panel.

1/2" thick steel letters. Painted color 4. Mounted flush to sign panel.

3 1/2" U/C text. Painted color 4. Mounted flush to sign panel.

1/4" thick steel letters. Painted color 5. Mounted flush to sign panel.

Painted color 3.

Painted color 1.

Loc. Plan: AS-106
Sign No.: A3.10.04 (S/F), A3.10.05 (S/F)
Color scheme A

Allowed Signage: ±1250 feet of frontage x 0.3 = 375 sq. ft. (60 sq. ft. maximum per Sign Code.)
 Proposed Signage: 4' x 3.5' = 14 sq. ft.

1 **DETAIL**
 SCALE: 1" = 1'-0"

2 **ADDITIONAL SIGN FACES**
 SCALE: 3/4" = 1'-0"

3 **ADDITIONAL SIGN FACES**
 SCALE: 3/4" = 1'-0"

ILLUM ASSOCIATES, INC.
 600 North Venture NE, Suite 660
 Bellevue, WA 98004
 T: 425.646.6525



CONTRACT NO.
 900
 CLIENT:
 City of Arlington

PROJECT:
 Arlington Municipal Airport:
 Exterior Signage Master Plan
 JOB NUMBER:
 : 313.003

100% SUBMITTAL:
 02/25/09

DETAILS:
 SIGN TYPE
 A3

SIGN TYPES:
 IDENTIFICATION

AS-217

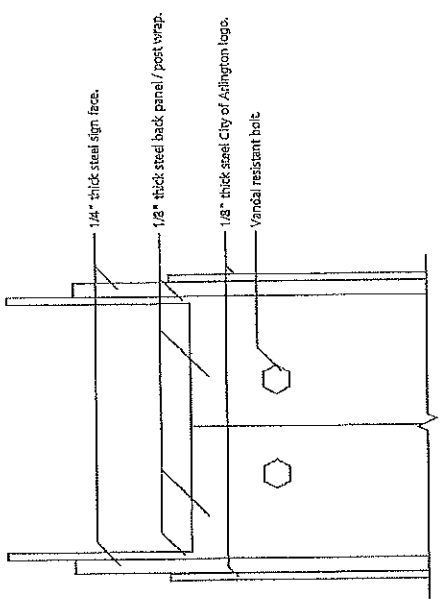

2 D/F SIDE VIEW DETAIL
 SCALE: 6"=1'-0"

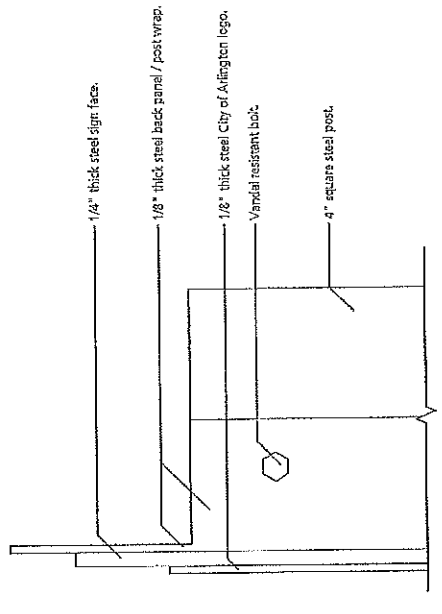

4 S/F SIDE VIEW DETAIL
 SCALE: 6"=1'-0"

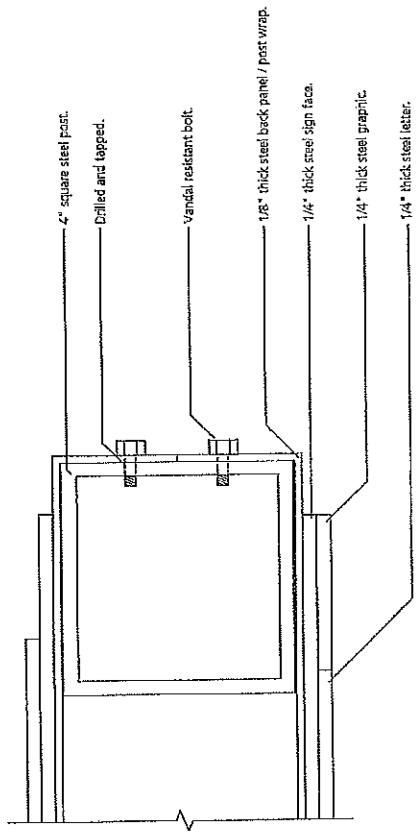

1 D/F DETAIL
 SCALE: 6"=1'-0"

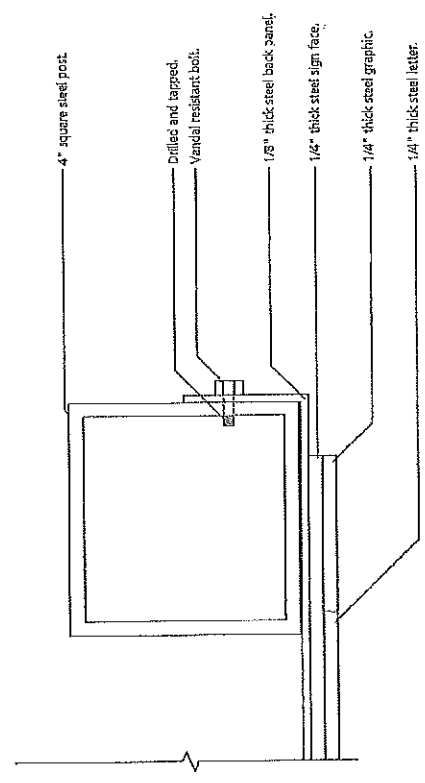

3 S/F DETAIL
 SCALE: 6"=1'-0"

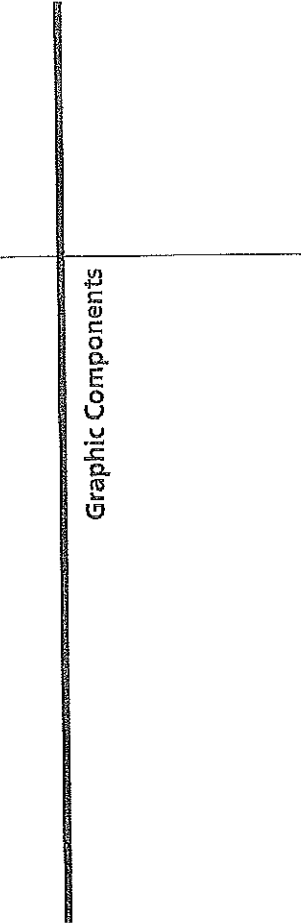

Graphic Components

PRIMARY MESSAGES

ABCDEFGHIJKLMNOPQRSTUVWXYZ
abcdefghijklmnopqrstuvwxyz
1234567890(.,:;!)

Futura T - Medium

MAPS &
DIRECTORIES ONLY
(for hierarchy purposes)

ABCDEFGHIJKLMNOPQRSTUVWXYZ
abcdefghijklmnopqrstuvwxyz
1234567890(.,:;!)

Futura T - Book Oblique

ABCDEFGHIJKLMNOPQRSTUVWXYZ
abcdefghijklmnopqrstuvwxyz
1234567890(.,:;!)

Futura T - Demi

ABCDEFGHIJKLMNOPQRSTUVWXYZ
abcdefghijklmnopqrstuvwxyz
1234567890(.,:;!)

Futura T - Bold

LETTER FORMS

Letter form should never be altered. Never extend or condense letters.

Aviation

Correct letter form

~~Aviation~~

Extended letter form

~~Aviation~~

Condensed letter form

LETTER SPACING

The space between each letter and word should always appear proportionally even. The letters and words should never appear to have uneven spacing. Custom kerning may be necessary to achieve visually consistent spacing.

Aviation

Correct letter spacing

~~Aviation~~

Letter spacing is too uneven

~~Aviation~~

Letter spacing is too open

~~Aviation~~

Letter spacing is too tight

NOTES:

- 1. All Fonts to be Adobe Postscript or approved equal.
- 2. Futura T available at www.myfonts.com

ILLUM
ILLUM ASSOCIATES, INC.
600 108th Avenue NE, Suite 660
Bellevue, WA 98004
T: 425.646.6525



CONTRACT NO.
000

CLIENT:
City of Arlington

PROJECT:
Arlington Municipal Airport
Exterior Signage Master Plan

JOB NUMBER:
1819.000

100% SUBMITTAL:
02/25/09

FONTS

GRAPHIC
COMPONENTS:
STANDARDS

AS-301

APPROVED ARROW

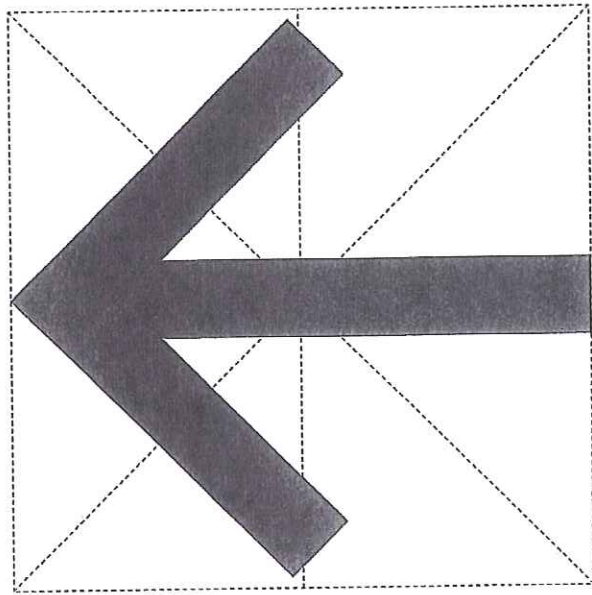





APPROVED USES

ORIENTATION	VEHICULAR DIRECTIONS	INTERPRETATION
		Ahead right or Up and right
		Right
		Right and down ramp
		Ahead
		Left and down ramp
		Left
		Ahead left or Up and left

ORIENTATION



NOTES

-  Do not customize orientations
-  Do not add background shape
-  Do not allow alternate orientations
-  Do not modify arrow shape

ILLUM
 ILLUM ASSOCIATES, INC.
 600 108th Avenue NE, Suite 660
 Bellevue, WA 98004
 T: 425.446.6525



CONTRACT NO.
020

CLIENT:
City of Arlington

PROJECT:
Arlington Municipal Airport;
Exterior Signage Master Plan

JOB NUMBER:
1819.000

100% SUBMITTAL:
02/25/09

ARROW

GRAPHIC COMPONENTS:
STANDARDS

AS-302



CONTRACT NO.
000

CLIENT:
City of Arlington

PROJECT:
Arlington Municipal Airport:
Exterior Signage Master Plan

JOB NUMBER:
1819.000

100% SUBMITTAL:
02/25/09

DISTRICT
COLOR-CODING
SYSTEM
AND
NOMENCLATURE

GRAPHIC
COMPONENTS:
DISTRICT CODING

NOMENCLATURE
 While it is recognized that other nomenclature may be used for internal purposes, the following is the approved nomenclature for all signage.

- Arlington Municipal Airport
- Eastside Aviation Services / Hangar Area
- Southwest Aviation Services / Hangar Area
- Northwest Aviation Services / Hangar Area
- T-Hangar / Ramp Area
- Airport Business Park
- Airport Industrial Park
- Commercial Business Area

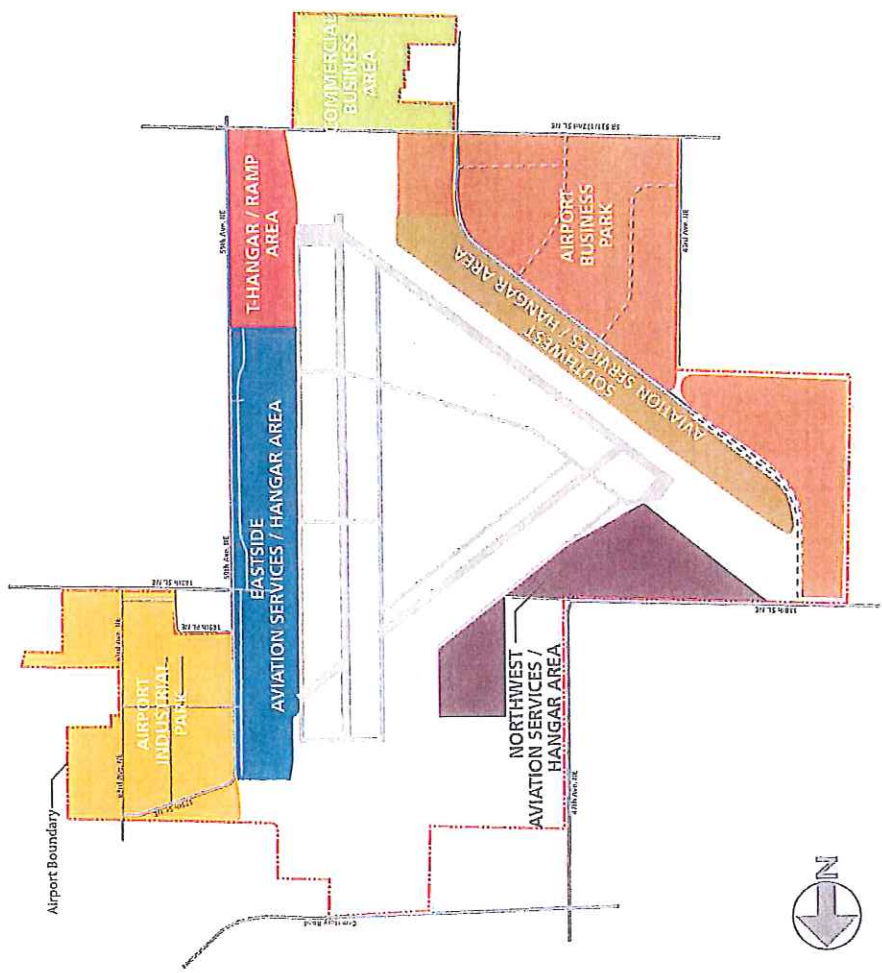

FACILITY COLOR-CODING
 Primary airport color-coding is by differentiating the major facility areas. Does not apply to runways.

COLOR-CODING	
	Color 1A MP02103 Airport (City wayfinding)
	Color 1B MP11183 Eastside Aviation Services / Hangar Area
	Color 1C MP06804 Southwest Aviation Services / Hangar Area
	Color 1D MP04956 Northwest Aviation Services / Hangar Area
	Color 1E MP14402 T-Hangar / Ramp Area
	Color 1F MP05462 Airport Business Park
	Color 1G MP00192 Airport Industrial Park
	Color 1H MP08818 Commercial Business Area

FACILITY IDENTITY

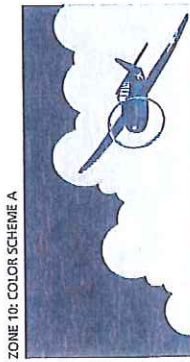

TFB-1 Avenger
Primary Airport Identification

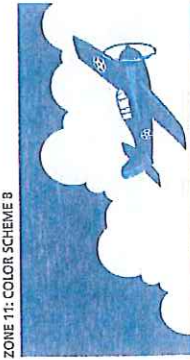

F4F-4 Wildcat
Eastside Aviation Services / Hangar Area



P-51 Mustang
Southwest Aviation Services / Hangar Area

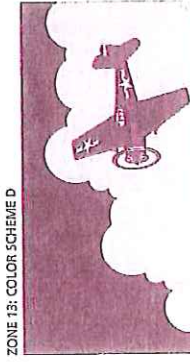

F6F-3 Hellcat
Northwest Aviation Services / Hangar Area



GB-1 Traveller
T-Hangar / Ramp Area

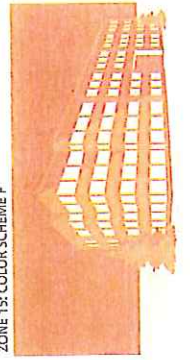

Office Building
Airport Business Park



Industrial Building
Airport Industrial Park



Commercial Building
Commercial Business Area

ILLUM
ILLUM ASSOCIATES, INC.
600 108th Avenue NE, Suite 660
Bellevue, WA 98004
T: 425.646.6525



CONTRACT NO.
000

CLIENT:
City of Arlington

PROJECT:
Arlington Municipal Airport
Exterior Signage Master Plan

JOB NUMBER:
1819.000

100% SUBMITTAL:
02/25/09

DISTRICT:
GRAPHICS THEME
SCHEDULE

GRAPHIC
COMPONENTS:
DISTRICT CODING

AS-304

NOTES:
1. Cloud configuration varies per sign type. Use sign type master art for fabrication.

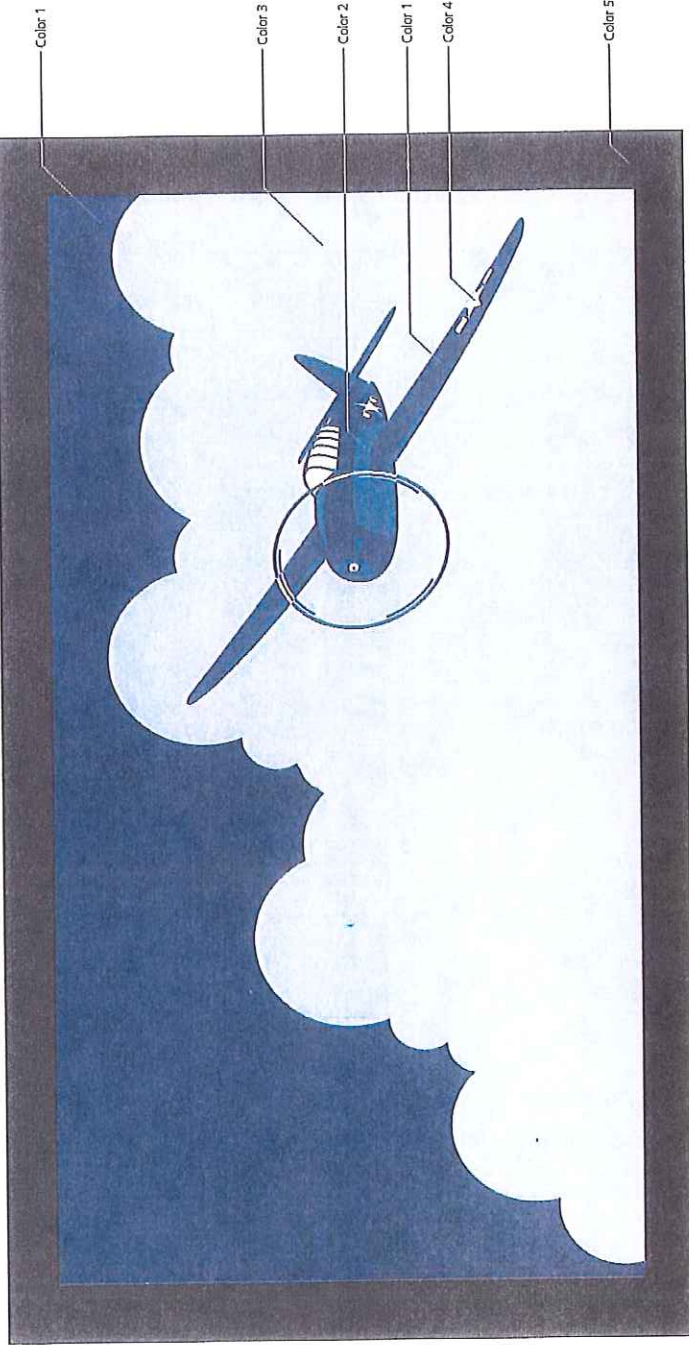

TYPICAL COLOR SCHEME

COLOR PALATE



- NOTES:
1. Colors 1, 2 & 3 vary per district color scheme. See AS-306 for specific colors.
 2. Color Scheme G & H, follow color layout on AS-304.

ILLUM
 ILLUM ASSOCIATES, INC.
 600 108th Avenue NE, Suite 660
 Bellevue, WA 98004
 T 425.646.6525



CONTRACT NO.
 020

CLIENT:
 City of Availington

PROJECT:
 Availington Municipal Airport:
 Exterior Signage Master Plan

JOB NUMBER:
 1819.000

100% SUBMITTAL:
 02/25/09

TYPICAL COLOR
 SCHEDULE

GRAPHIC
 COMPONENTS:
 COLOR

AS-305

DISTRICT COLOR SCHEMES

<p>ZONE 10: COLOR SCHEME A</p> <p>Color 1A MP02103</p> <p>Color 2A MP11958</p> <p>Primary Airport Identification</p>	<p>Color 3A MP00962</p> <p>Color 4 Mathews 422025P</p>	<p>Color 1F MP05462</p> <p>Color 2F MP07856</p> <p>Color 3F MP01825</p> <p>Color 4 Mathews 422025P</p> <p>Zone 15: COLOR SCHEME F</p> <p>Airport Business Park</p>	<p>Color 1B MP11183</p> <p>Color 2B MP05576</p> <p>Color 3B MP05654</p> <p>Color 4 Mathews 422025P</p> <p>Zone 11: COLOR SCHEME B</p> <p>Eastside Aviation Services / Hangar Area</p>	<p>Color 1G MP01442</p> <p>Color 2G MP08846</p> <p>Color 3G MP01451</p> <p>Color 4 Mathews 422025P</p> <p>Zone 16: COLOR SCHEME G</p> <p>Airport Industrial Park</p>	<p>Color 1C MP00804</p> <p>Color 2C MP00825</p> <p>Color 3C MP11955</p> <p>Color 4 Mathews 422025P</p> <p>Zone 12: COLOR SCHEME C</p> <p>Southwest Aviation Services / Hangar Area</p>	<p>Color 1D MP04928</p> <p>Color 2D MP11959</p> <p>Color 3D MP01663</p> <p>Color 4 Mathews 422025P</p> <p>Zone 13: COLOR SCHEME D</p> <p>Northwest Aviation Services / Hangar Area</p>	<p>Color 1E MP4402</p> <p>Color 2E MP11956</p> <p>Color 3E MP07489</p> <p>Color 4 Mathews 422025P</p> <p>Zone 14: COLOR SCHEME E</p> <p>T-Hangar / Ramp Area</p>	<p>Color 1H MP00818</p> <p>Color 2H MP01510</p> <p>Color 3H MP01519</p> <p>Color 4 Mathews 422025P</p> <p>Zone 17: COLOR SCHEME H</p> <p>Commercial Business Area</p>
---	--	--	---	--	--	--	--	---

- NOTES:**
- Color 1 is the primary color for each scheme, to be used for all color-coding applications.
 - Additional colors within schemes are not recommended.

ILLUM
ILLUM ASSOCIATES, INC.
600 108th Avenue NE, Suite 660
Bellevue, WA 98004
T: 425.646.6525



CONTRACT NO.
000

CLIENT:
City of Arlington

PROJECT:
Arlington Municipal Airport:
Exterior Signage Waiver Plan

JOB NUMBER:
1819.000

100% SUBMITTAL:
02/23/09

**DISTRICT COLOR
SCHEDULES**

**GRAPHIC
COMPONENTS:
COLOR**

AS-306

CITY IDENTITY

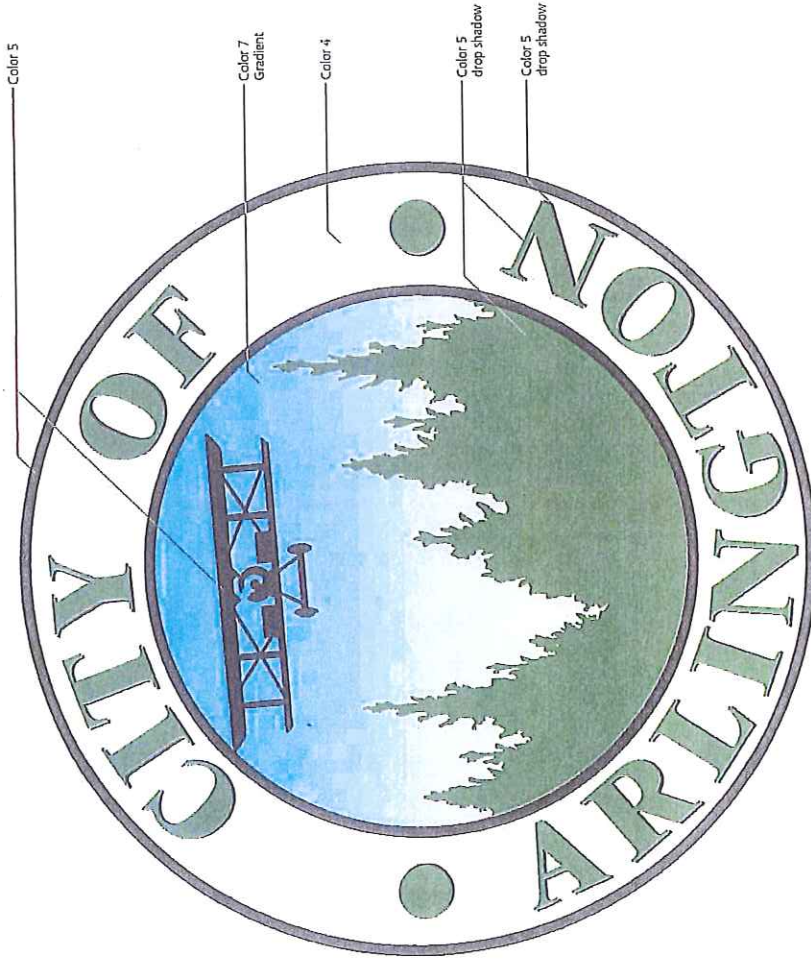

CITY LOGO COLORS

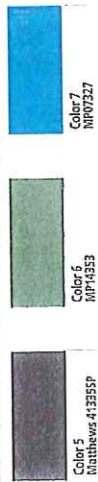

CITY LOGO COLORS
(PRINT)



CITY IDENTIFICATION

GRAPHIC COMPONENTS:
SYMBOLS

AS-307

ILLUM
ILLUM ASSOCIATES, INC.
600 108th Avenue NE, Suite 660
Bellevue, WA 98004
T: 425.646.6525



CONTRACT NO.
000

CLIENT:
City of Arlington

PROJECT:
Arlington Municipal Airport
Exterior Signage Master Plan

JOB NUMBER:
1819.000

100% SUBMITTAL:
02/25/09

PRIMARY BASE VENEER
Primary and secondary
sign types.

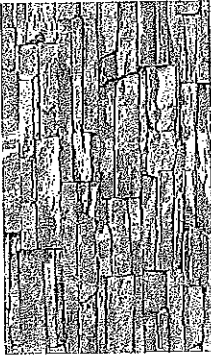

Eldorado Stone: Slate Gray Stacked Stone
dry-stack grout technique

TERTIARY BASE MATERIAL
Trail Markers



Decorative Exposed Aggregate

ILUMI
ILLUMI ASSOCIATES, INC.
600 108th Avenue NE, Suite 660
Bellevue, WA 98004
T: 425.646.6525



CONTRACT NO.
000

CLIENT:
City of Arlington

PROJECT:
Arlington Municipal Airport
Exterior Signage Master Plan

JOB NUMBER:
1819.000

100% SUBMITTAL:
02/25/09

MATERIALS

GRAPHIC
COMPONENTS:
GENERAL

AS-308

1. Final Materials to be determined in construction phase.

NOTES